



NEW!

KRT 21 Kabel-Rohrträger

Kunststoff Montageträger für Kabel und Rohre

Support de montage en plastique pour des câbles et des tuyaux

Supporto di montaggio in plastica per cavi e tubi



Zweilagige Rohrführung
Sur deux niveaux
Su due piani



Halogenfrei
Sans halogènes
Senza alogeni



Stopp-KRFG
Stopp-THFG
Stopp-THFG



3 Montagemöglichkeiten
3 options de montage
3 opzioni di montaggio

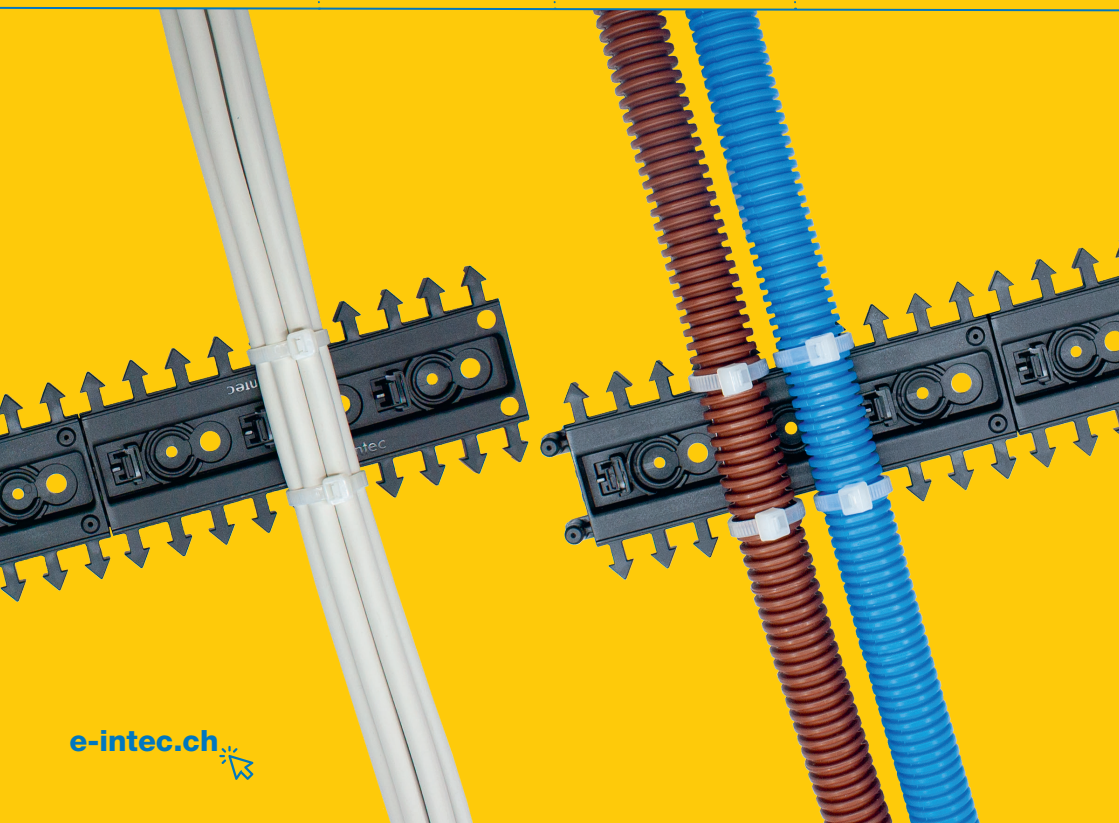

KRT 21 Kabel-Rohrträger

1 Flexibler Kunststoff Plastique flexible Plastica flessibile

D Flexibler Kunststoff garantiert kein Abbrechen der Hacken, sehr robust und schlagfest.

F Le plastique flexible garantit que les crochets ne se cassent pas, très robuste et résistant aux chocs.

I La plastica flessibile garantisce che i ganci non si rompano, molto robusta e resistente agli urti.

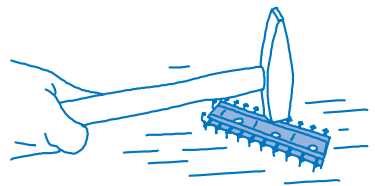
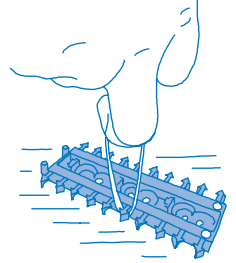

2 Montagemöglichkeiten Options de montage Opzioni di montaggio

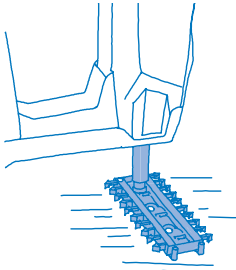

Akku-Bolzenschussgerät
Clouage à batterie
Chiodatrice a batteria

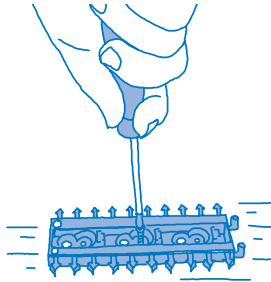

Schraubenzieher
Tournevis
Cacciavite

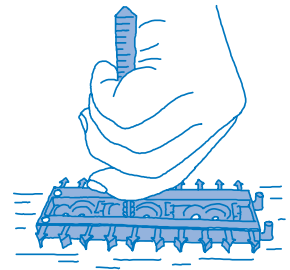

TA Steckdübel
TA Cheville enfichable
TA Tassello ad innesto

D TA – Traganker 100/25 und 30/25 zur Verwendung mit dem KRT für zweilagige Rohrführung und Ordnungstrennung.

F TA – Ancres de support 100/25 et 30/25 à utiliser avec le support KRT pour montage des tuyaux sur deux niveaux et la séparation.

I TA – Ancoraggi di supporto 100/25 e 30/25 da utilizzare con il supporto KRT per posa dei tubi su due livelli e la separazione.

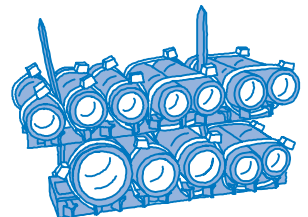

3 Rohr-Stopp-Kante Bord d'arrêt du tuyau Bordo di arresto del tubo

D Durch die aufgesetzte Rohr-Stopp-Kante kann das KRFWG-Rohr gespannt werden. Für höhere Spannkraft über zwei Hacken befestigen.

F Le tuyau THFWG peut être tendu grâce au bord d'arrêt du tuyau fixe. Fixez sur deux crochets pour une plus grande force de serrage.

I Il tubo THFWG può essere messo in tensione attraverso il bordo di arresto del tubo attaccato. Fissare su due ganci per una maggiore forza di serraggio.

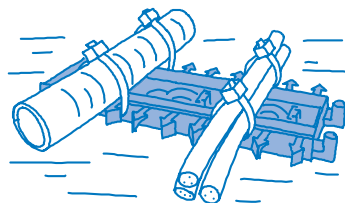
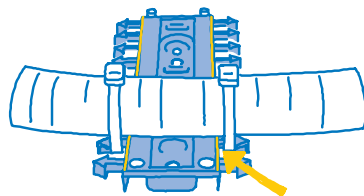

4 Grösse – Anreihbar Dimension – extensible Dimensione – espandibile

D Dank der optimierten Grösse, ideal für enge Platzverhältnisse und bessere Längeneinteilung

F Grâce à la dimension optimisée, idéale pour les espaces restreints et une meilleure répartition des longueurs.

I Grazie alle dimensioni ottimizzate, ideali per spazi ristretti e una migliore divisione della lunghezza

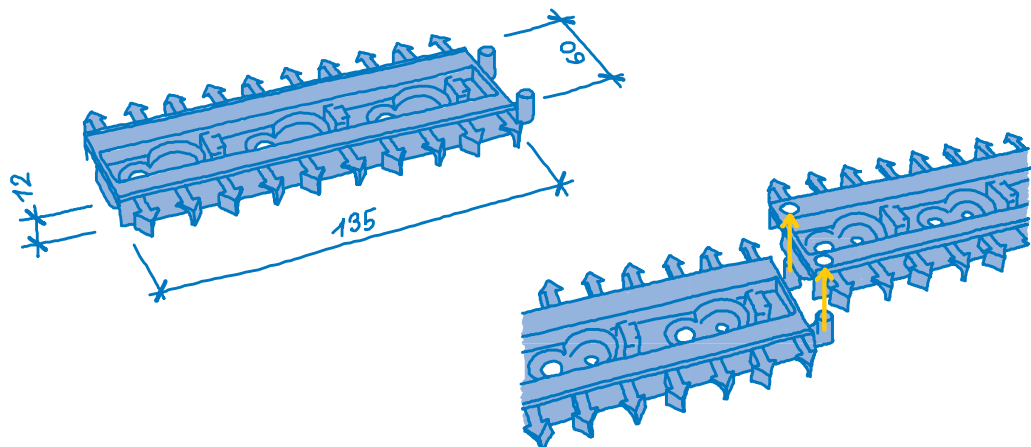

KRT 21 Kabel-Rohrträger

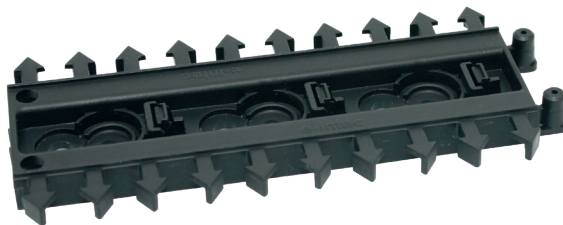

KRT 21/135 | 135 x 60 x 12 mm

VPE: 100 Stk. | UE: 100 pcs

E.No: 120 068 279



KRT 21/270 | 2 à 135 x 60 x 12 mm

VPE: 50 Stk. | UE: 50 pcs

E.No: 120 068 379



TA Traganker 30/25mm und 100/25mm



TA 30/25 | 30 mm

VPE: 100 Stk. | UE: 100 pcs

E.No: 120 069 279



TA 100/25 | 100 mm

VPE: 100 Stk. | UE: 100 pcs

E.No: 120 069 179

