



GOBIERNO  
DE ESPAÑA

MINISTERIO  
DE INDUSTRIA, ENERGÍA  
Y TURISMO

MINISTRY OF INDUSTRY, ENERGY AND TOURISM  
LICOF: Official Laboratory for Fire Testing  
R.D. 1614/1985 on 1st of August  
M.O. on 21st of May of 1991



AFITI  
LICOF

Centre for Fire Testing  
and Research

Association for the Promotion of Research and Fire Safety Technology

# Test Report

---

## Fire Resistance Laboratory

### APPLICANT:



JSL – Material Eléctrico S.A

### TEST:

Determination of the **Fire Resistance**.

- Test standard: Test protocol based on *DIN 4102-12:1998*
- Specimen: Electrical boxes fire resistant.
  - Manufacturer: JSL – Material Eléctrico S.A
  - References: “J100B-F”; “J100B-F”; “J160B-F”; “J200B-F”

## APPLICANT

**JSL – Material Eléctrico S.A.**  
 Rua Mário Castelhana nº 3  
 Zona Industrial Queluz de Baixo Ap. 12  
 2746-953 Queluz Portugal

---

Quotation acceptance date: 20<sup>th</sup>-Feb-2013

## TEST SPECIMENS

Type of specimen: Electrical boxes fire resistant.  
 Manufacturer: JSL – Material Eléctrico S.A  
 References: “J100B-F”; “J100B-F”; “J160B-F”; “J200B-F”

## TESTS PERFORMED

Fire Resistance test protocol according to **DIN 4102-12:1998**

---

Test date: 11<sup>th</sup>-feb-2013  
 Place of test performance: Arganda del Rey’s facilities



## Report contents

1.- Test specimens	.....	Page 3
2.- Test performed	.....	Page 4
3.- Specimens assembly	.....	Page 5
4.- Test conditions	.....	Page 5
5.- Results	.....	Page 6
6.- Classification	.....	Page 7
<hr/>		
ANNEX 1: Graphic of evolution of temperature inside the furnace.	.....	Page 9
ANNEX 2: Photographs	.....	Page 10
ANNEX 3: Technical report	.....	Page 12



This report is a translation of the Spanish Test Report dated 21<sup>st</sup>-Mar-13. In case of doubt, the Spanish version of the Test Report prevails

The results of this Test Report make sole and exclusive reference to the specimen tested, and not to the product in general.

*“This test report details the construction method, test conditions and achieved results when a specific construction item, as the one herewith described, has been tested following the procedure described in DIN 4102-2. Any significant deviation regarding size, construction details, loads, tensions, sample limits or extremes of this, which are not included in the test results direct scope specified in the correspondent test method, will not be covered by this test report”.*

The information held in this Test Report is of a confidential nature, meaning the Laboratory will not provide information in relation to this report to third parties, except with the authorization of the Applicant.

It is not allowed to reproduce partially this Test Report without the Laboratory’s written approval

## 1.- TEST SPECIMENS

**Reception:** 11<sup>st</sup> -Mar-2013

- Units: 7 specimens
- The specimens and all the components are received packaged.
- The specimens have been sent and selected by the applicant.

### Documentation:

The technical documentation required for the issuance of this report has been received on 11<sup>st</sup> -Mar-2013.

### Description:

The main descriptive characteristics of the specimens have been supplied by the applicant. This information is included in the Annex 3 of this Test Report.

Specimen	Reference	Dimensions	Classification
8855A	J100B-F	116 x 116 x 60	E90
8855B	J100B-F	116 x 116 x 60	E90
8855C	J160B-F	166 x 116 x 70	E90
8855D	J200B-F	216 x 116 x 90	E90

The specimen 8855B is protected by a metal casing of dimensions (120 x 127 x 65) mm and 1 mm thickness:

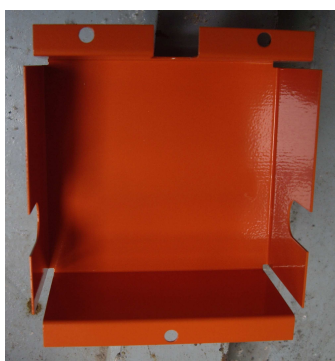

## 2.- TESTS PERFORMED

Due to there is no standard for this kind of products, the fire test according to **DIN 4102-12:1998** has been adapted in order to evaluate the performance of these electrical boxes.

Due to the functionality in case of fire of these electrical boxes is to maintain the circuit integrity, the specimens were subjected to standard fire conditions defined by DIN 4102-2 checking by passing current through systems cables, wherein said current flow is maintained throughout the heating process.

### Test parameters

- Heating Curve: According to the thermal program described by the Standard DIN 4102-2:1977-09. The temperature control is performed by placing 4 Ø 1,6 mm type K sheathed thermocouples placed 100mm apart from the plane of the specimen.
- Specimen connection: Since the objective is to verify the supply continuity, if one of the electrical phases fails the entire system supply fails. The switch poles have been fed by high temperature resistant cables and these cables feed some bulbs in order to detect the possible failure of supply continuity.
- Connection cable: To evaluate the supply continuity, the following types of cables had been used in each specimen:

Specimen	Cable Type	Outer Diameter (mm)
<b>8855A</b>	TUMKA NHXH FE180 E90 2x1,5mm <sup>2</sup> 0,6/1 kV	13,30
<b>8855B</b>	TUMKA NHXH FE180 E90 2x1,5mm <sup>2</sup> 0,6/1 kV	13,30
<b>8855C</b>	TUMKA NHXH FE180 E90 2x1,5mm <sup>2</sup> 0,6/1 kV	13,30
<b>8855D</b>	TUMKA NHXH FE180 E90 2x1,5mm <sup>2</sup> 0,6/1 kV	13,30
	TUMKA NHXH FE180 E90 3x2,5mm <sup>2</sup> 0,6/1 kV	14,90

### Classification criteria

In accordance with DIN 4102-12:1998 paragraph 3.2.2, the specimens are classified according to the following table:

**Table 1: Circuit integrity classes**

Class	Shortest length of time circuit integrity is maintained, in minutes
E 30	30
E 60	60
E 90	90

Considering that the operating time is the time during which the integrity of the electrical circuit is maintained.



### 3.- SPECIMEN ASSEMBLY

The specimens were installed vertically on a wall of lightweight concrete with the arrangement given below:

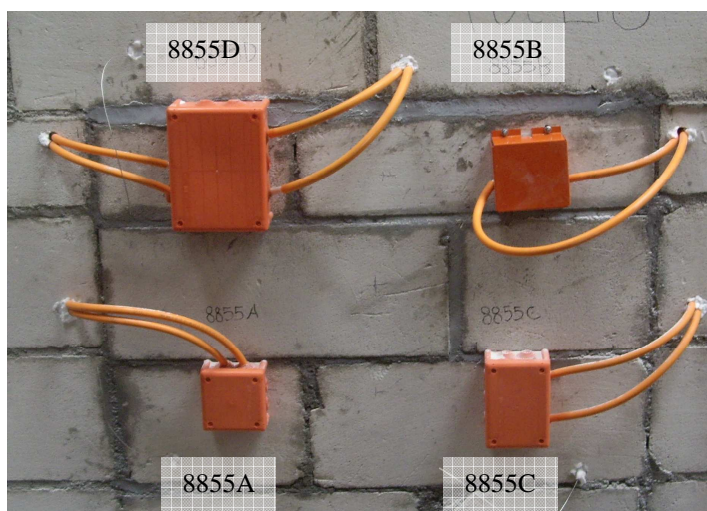

Once the specimens have been installed electrical connections are made from each of the specimens separately.

The power supply is three-phase ( $400 \pm 40$ ) V and 50 Hz with neutral ground at least 3 A and short circuit current  $\geq 10$  A. This current is taken directly from the control panel of the laboratory. Fuses of conductor protection with nominal current of 3A and bulbs with nominal tension of 240 V nominal electric power of 60 W and luminescent diode to indicate the current flow.

### 4.- TEST CONDITIONS

<b>Furnace temperature. Heating curve.</b>	According to the thermal program described by the Standard DIN 4102-2:1977-09.	
<b>Electrical conditions</b>	380V 50Hz	
<b>Ambient conditions at the beginning of the test.</b>	Ambient temperature ( $^{\circ}\text{C}$ ) $\equiv T_0$	12
	Relative humidity (%)	62

## 5.- RESULTS

The test lasted 91 minutes.

The test was stopped by mutual agreement with the applicant after 91 minutes.

### Observations during the test

Minute	Observation
0	..... The test starts at 16h 48min 42s
30	..... Without significant changes.
60	..... Without significant changes.
90	..... Without significant changes.
91	..... End of the test by mutual agreement with the applicant.

### Observations after the test

After the test the melting of the plastic elements and the integrity of the metal case of the specimen 8855B is observed.

The electrical circuit continuity is successfully checked.

### Expression of results

	Specimen			
	8855A	8855B	8855C	8855D
<b>Circuit integrity (E)</b>	<b>91 minutes</b>	<b>91 minutes</b>	<b>91 minutes</b>	<b>91 minutes</b>
<b>Continuity after the test</b>	<b>COMPLIES</b>	<b>COMPLIES</b>	<b>COMPLIES</b>	<b>COMPLIES</b>



## 6.- CLASSIFICATION

Assimilating the classification as provided in DIN 4102-12:1998 paragraph 3.2.2, tested specimens could be classified such as:

Muestra	Referencia	Dimensiones	Tipo de Cable	Clasificación
8855A	J100B-F	116 x 116 x 60	TUMKA NHXH FE180 E90 2x1,5mm <sup>2</sup> 0,6/1 kV	<b>E90</b>
8855B	J100B-F	116 x 116 x 60	TUMKA NHXH FE180 E90 2x1,5mm <sup>2</sup> 0,6/1 kV	<b>E90</b>
8855C	J160B-F	166 x 116 x 70	TUMKA NHXH FE180 E90 2x1,5mm <sup>2</sup> 0,6/1 kV	<b>E90</b>
8855D	J200B-F	216 x 116 x 90	TUMKA NHXH FE180 E90 2x1,5mm <sup>2</sup> 0,6/1 kV	<b>E90</b>
			TUMKA NHXH FE180 E90 3x2,5mm <sup>2</sup> 0,6/1 kV	<b>E90</b>

*“Due to the nature of fire Performance tests and the consequent difficulty in measuring the uncertainty of the grade of fire resistance, it is not possible to show a known degree of accuracy in the result”.*

Arganda del Rey, 03<sup>rd</sup> April of 2013



Document Signed Digitally

Signed: Agustín Garzón Cabrerizo  
Technical Director of  
Fire Resistance Laboratory  
Technical Director of LICOF



DOCUMENT SIGNED  
DIGITALLY



# Annexes





# Annex 1

Graphic of evolution of temperatures inside the furnace



Test Report nr 8855/13  
English Version

### Evolution of the average furnace temperature and standard curve

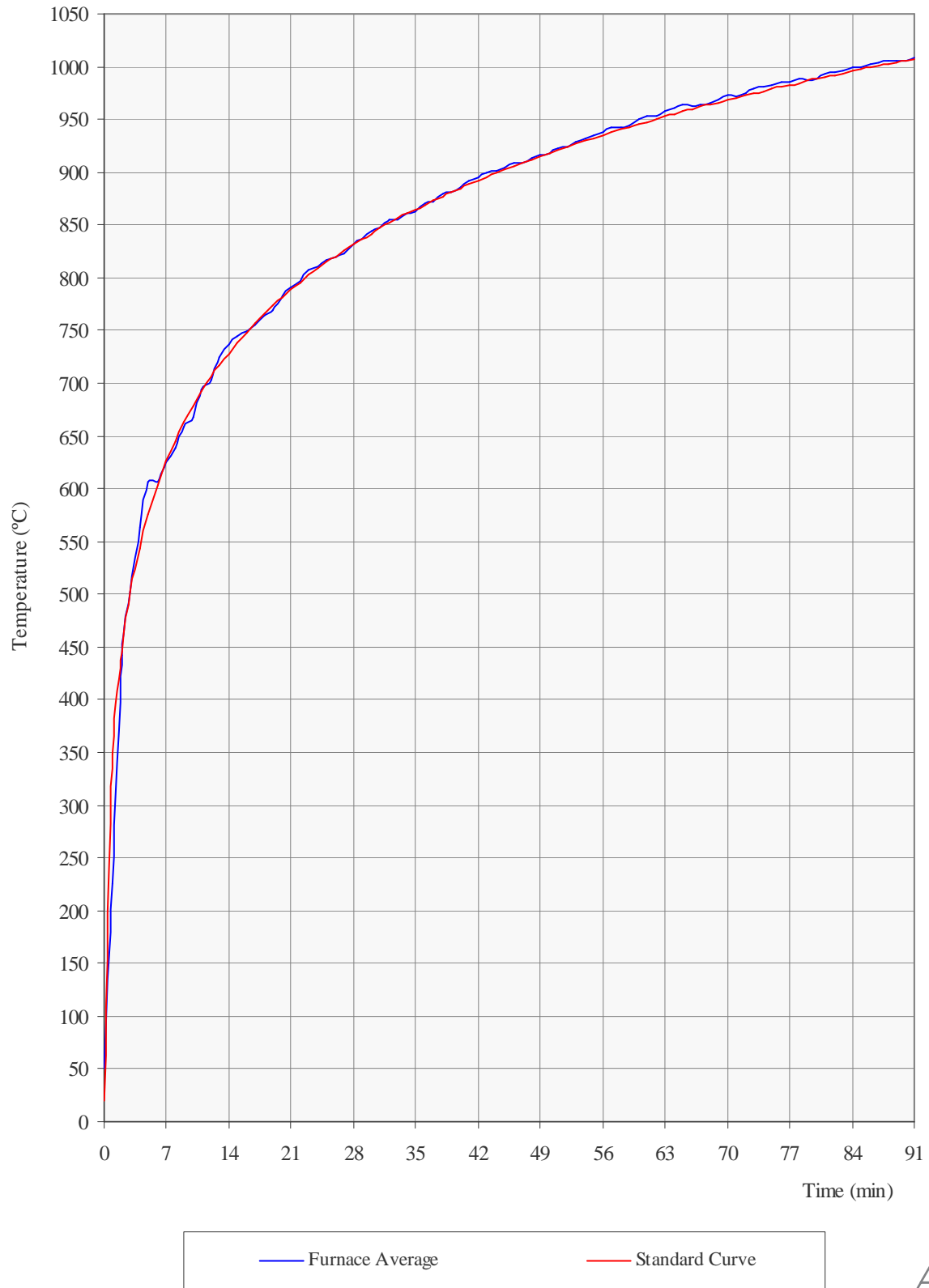



Photograph nr 1

Detail of the specimens 8855A y 8855B

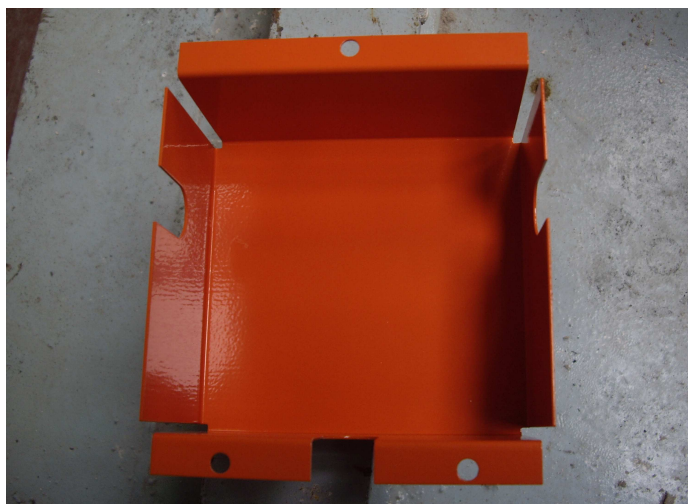

Photograph nr 2

Detail of the steel casing. Specimen 8855B



Photograph nr 3

Detail of the specimen 8855C

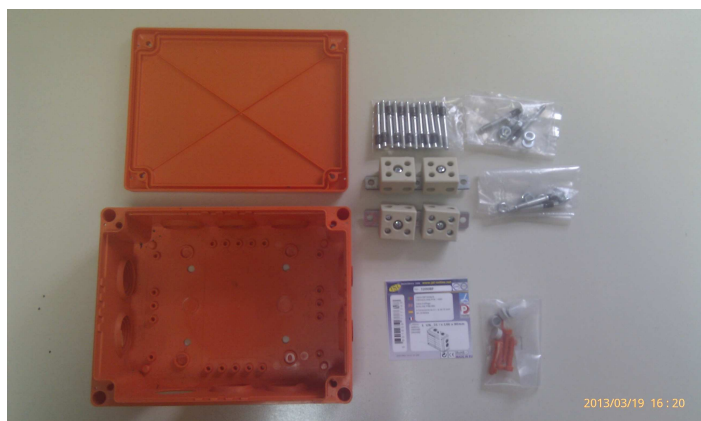

Photograph nr 4

Detail of the specimen 8855D

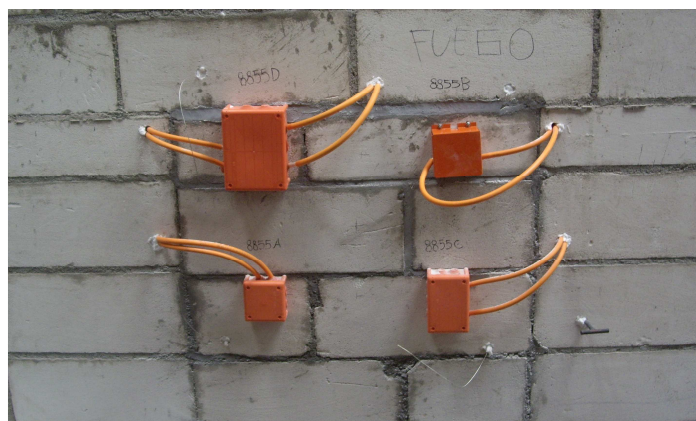

Photograph nr 5

Aspect of the specimens 8855A, 8855B, 8855C, 8855D  
before the test



Photograph nr 6

Aspect of the specimens 8855A, 8855B, 8855C, 8855D after finishing the test







## Fireproof JSL E90

# BOXLINE waterproof Boxes



diam. 6mm

40 mm

[www.jsl-online.net](http://www.jsl-online.net)



DOCUMENT SIGNED DIGITALLY



## **E90 BOXLINE FIRE waterproof junction boxes from JSL**

### Functionality:

Full functionality for 90 minutes (Category E90) according to DIN 4102 Part 12. For circuits and wiring installations where safety of the facilities are crucial, such: power generation places, emergency lighting, fire detection, alarm detectors and security in general, ventilation and smoke exhaust and control of fire attack equipment such as fire pumps, "springlers." Circuit and related devices.

### Suitable for:

Assembling and manufacturing lines, Metropolitan tunnels, garages, security zones and emergency or evacuation paths, Central control headroom's, hospitals, schools and electrical and telecommunications "survival" lines in general. Also suitable for environments with corrosive, humid or with extreme temperatures environments or submitted to severe IK shock.

### Special Features:

- Halogen free raw materials,
- IP66
- IK08
- Under normal temperature environment conditions: -15 ° C to +45 ° C
- Walls mounting through-anchor bushings steel treated for fire conditions Certified by Deutsches Institut für Bautechnik
- Steatite ceramics connectors-, high furnace temperature resistance.
- Insulation class II
- Boxes; Duroplast extinguishing V0 in color RAL 2003, KEMA-KEUR certified according IEC EN 60670-22

### Dimensions and References:

- J100B-F: 116x116x60 mm, accepts cables or tubes from 4 to 25 mm diameter.
- J100S-F: 116x116x60 mm receiving directly Metric Glands M20 V0 for cables from 8 to 13 mm external diameter or VD16 and/ or VD20 tube, using threaded mouthpiece M20GSV from JSL.
- J160B-F: 166x116x70 mm, accepts cables or tubes from 4 to 25 mm diameter.
- J200B-F: 216x166x90 mm, accepts cables or tubes from 4 to 32 mm diameter.

### Connection capacity:

- 6 poles, each pole supporting rigid or flexible copper conductors from 0.5 mm<sup>2</sup> to 4 mm<sup>2</sup>. in the case of the references J100B-F and J100S-F.
- 8 poles, each pole supporting rigid or flexible copper conductors. From 0.5 mm<sup>2</sup> to 6 mm<sup>2</sup>. in the case of the references J160B-F.
- 8 poles, each pole supporting rigid or flexible copper conductors from 0.5 mm<sup>2</sup> to 10 mm<sup>2</sup>. in the case of the references J200B-F.

NOTICE: The boxes may be provided with other ceramic connectors capabilities (if necessary). Suitable for cables: Dätwyler, Eupen, Nexans, Pirelli, Leoni Studer, Helukabel, Prysmian and others in accordance with DIN 4102 Part 12. **IMPORTANT:** the listed wiring capacity of the terminal ceramic blocks, it's merely an indication..

### **JSL, Material Eléctrico SA**

#### **Sede/Headquarters/Siège Social**

Rua Mário Castelhan, N.º 3 - Apartado 12.  
Zona Industrial Queluz de Baixo  
2746 - 801 Queluz - Portugal  
Tel (+351) 21 434 46 70 Fax (+351) 21 435 31 50  
M (+351) 91 997 50 67 / (+351) 93 253 52 55 / (+351) 96 273 67 09  
Email: [info@jst-online.net](mailto:info@jst-online.net) WEB: [www.jst-online.net](http://www.jst-online.net)

#### **Sucursal em Espanha/Branch office in Spain/Filiale en Espagne**

Avenida Democracia, nº7 Nave 112 Planta 1, 28031 Madrid - España  
Tel (+34) 91 332 28 28 Fax (+34) 91 332 0151 info.jst@gmail.com  
**Sucursal na Polónia /Branch office in Poland /Filiale en Pologne**  
JSL Polska  
Ul. Ceglana 13, 05-250 Słupno, Warszawa - Polska  
Tel (+48) 223 961 046 M (+48) 666 878 600 Fax (+48) 224 358 763





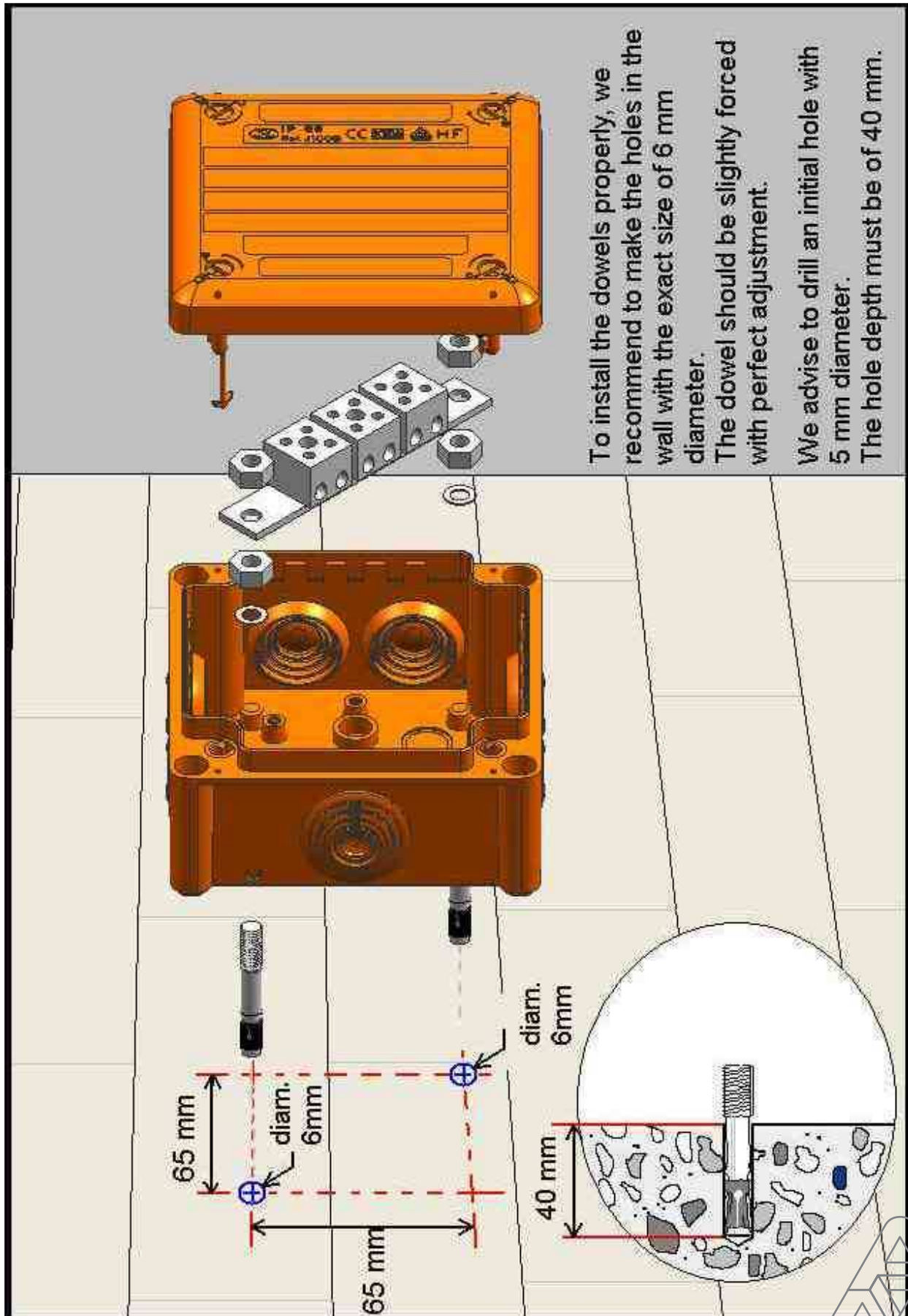

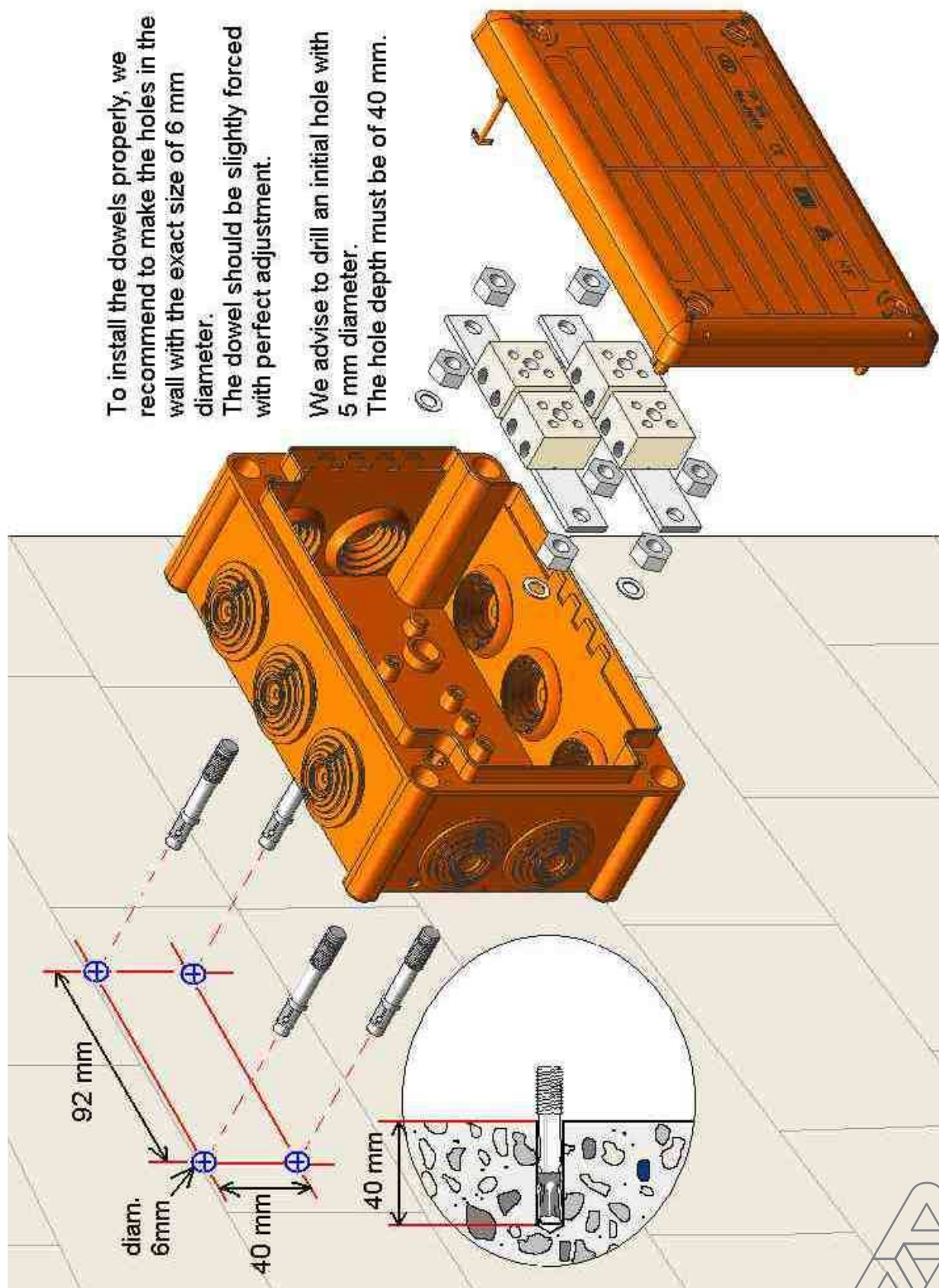



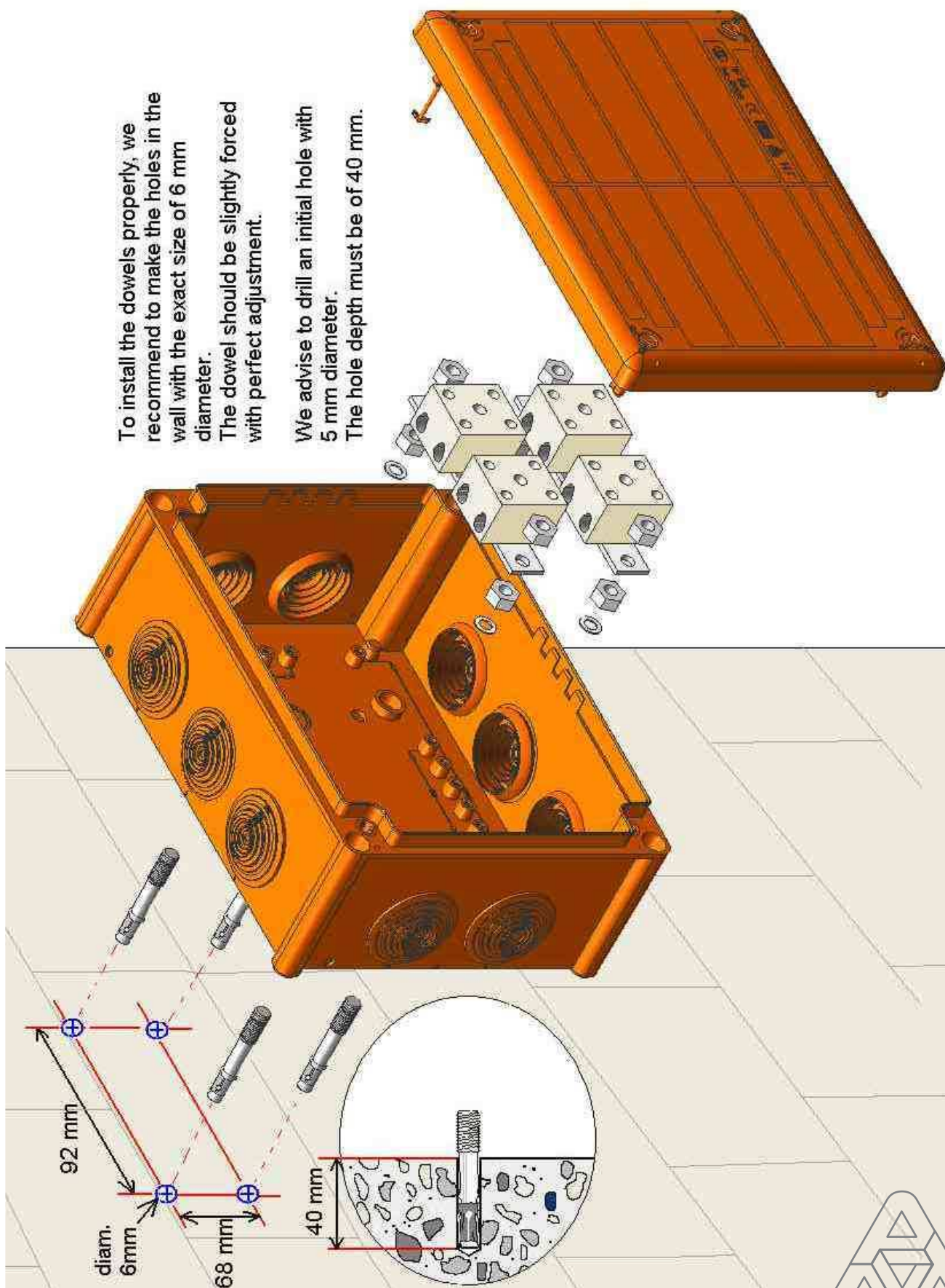

**Installers Manual for JSL BOXLIN FIRE boxes ref. J100BF, Ref. J160BF and Ref. J200BF**

**Fixing:**

The boxes can be fixed by internal fixing holes according datasheet and figures supplied with each box in case of fixing on concrete walls or ceilings.

Drill the holes to put the special metal dowels. Insert the metal dowels on the concrete walls according the image supplied. Fix the box using the pre-made holes on the base of the box, put the washers and screw the M6 nuts like in the figure.

In case of cable tray use, the dowels supplied must be changed by "Umbrako" M6x25 steel screws. This screws will fix the cable tray plates to the Boxline Fire E90 Boxes.

**Cable and tube installation:**

BF version with stepped rubber grommets:

Cut the grommet at the mark corresponding to the diameter of the cable or tube and insert cable through the hole created. See the following figure:

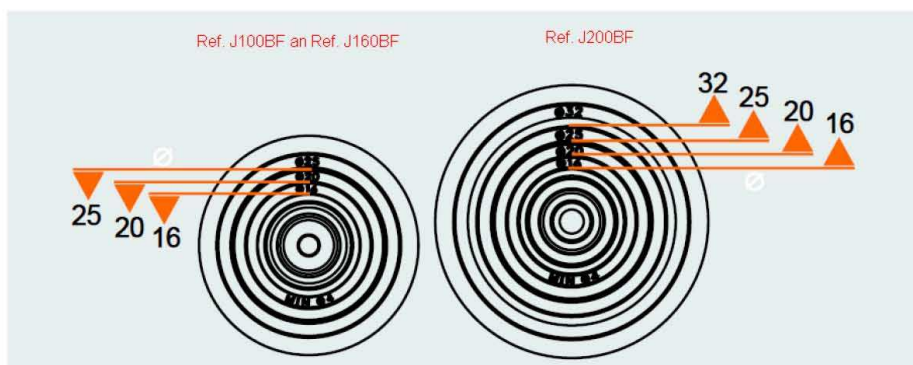

**Bars and wires connection:**

Connect the wires of the E90 cables to the Steatite bars according the projected circuit and the type and capacity of the bars ordered.

**PLEASE BE CAREFUL with the layout and the proper separation of the wires and between wires and the metal parts fixing components. Earth fixing screws must be ordered in case of necessity of earth protection for the supporting bar and dowels. It's advised to use rock wool mate in order to prevent any contact or connection between crossing wires and the metal supporting bars**

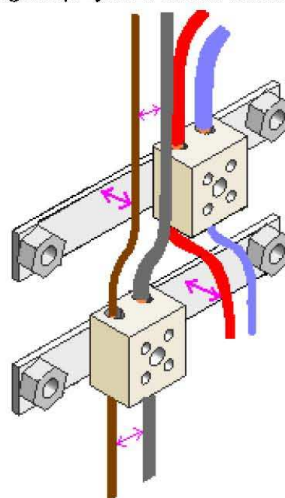

**Box closing:**

For all the models: put the cover and the supplied special screws in the 4 holes and then screw them (3/4 of turn)



JSL Boxline Fire external and internal dimensions:

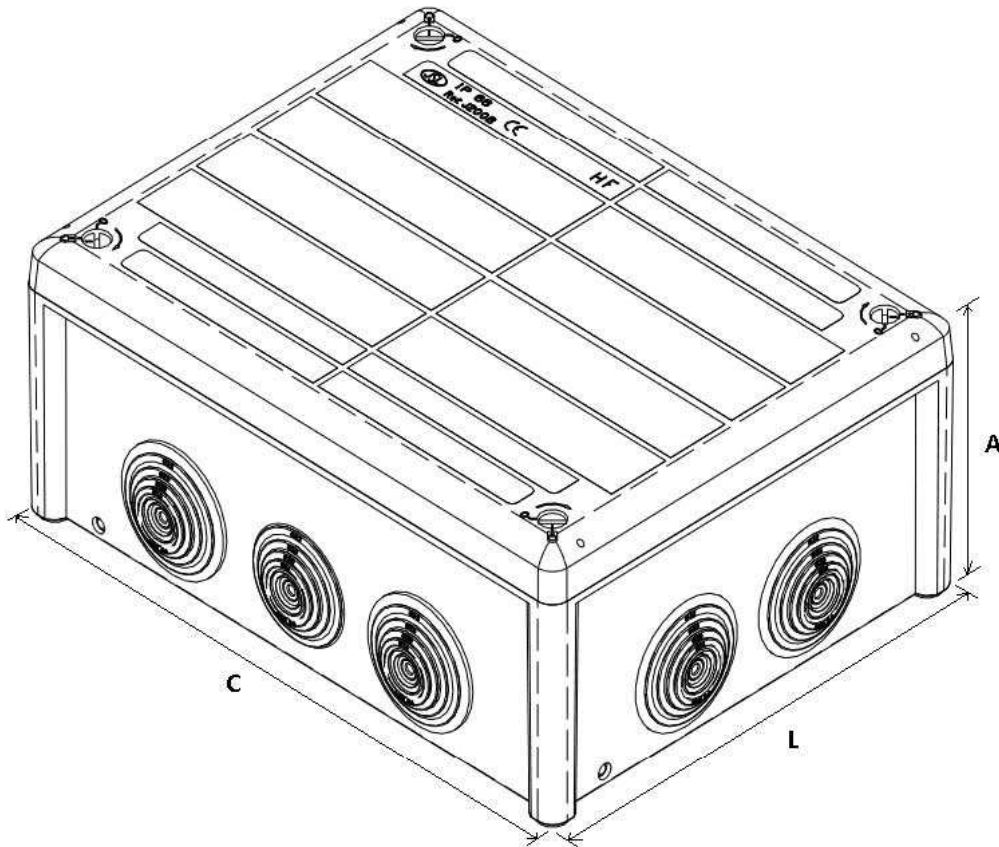

Ref. J100B, BOX 100 x 100 with 7 h entries supplied with grommets and ¼ turn fast cover fixing screw (external dimensions: 115x115x60 mm, internal dimensions; 102x102x56 mm)

**L C A**

Ref. J160B, BOX 100 x 160 with 10 entries supplied with grommets and ¼ turn fast cover fixing screw . (external dimensions: 115x165x70 mm, internal dimensions; 102x153x67 mm)

**L C A**

Ref. J200B, BOX 160 x 200 with 10 entries supplied with grommets and ¼ turn fast cover fixing screw . (external dimensions: 165x216x89 mm, internal dimensions; 153x205x87 mm)

**L C A**





# CERTIFICATE

Issued to:  
Applicant:  
**JSL Material Electrico S.A.**  
Rua Mário Castelhana Nº 3  
2746 Queluz De Baixo Apartado 12  
Portugal

Manufacturer/Licensee:  
**JSL Material Electrico S.A.**  
Rua Mário Castelhana Nº 3  
2746 Queluz De Baixo Apartado 12  
Portugal

Product : connecting box for fixed electrical installations  
Trade name : JSL  
Types : J100L, J100B and J100S

The product and any acceptable variation thereto is specified in the Annex to this certificate and the documents therein referred to.

DEKRA hereby declares that the above-mentioned product has been certified on the basis of:

- a type test according to the standard IEC 60670-1:2002, IEC 60670-22:2003 and IEC 62262:2002
- an inspection of the production location according to CENELEC Operational Document CIG 021
- a certification agreement with the number 961626

DEKRA hereby grants the right to use the KEMA-KEUR certification mark.

The KEMA-KEUR certification mark may be applied to the product as specified in this certificate for the duration of the KEMA-KEUR certification agreement and under the conditions of the KEMA-KEUR certification agreement.

This certificate is issued on: 13 May 2011 and expires upon withdrawal of one of the above mentioned standards.

**Certificate number: 2143500.02**

DEKRA Certification B.V.



drs. G.J. Zoetbrood  
Managing Director

H.R.M. Barends  
Certification Manager

© Integral publication of this certificate is allowed

All testing, inspection, auditing and certification activities of the former KEMA Quality are an integral part of the DEKRA Certification Group.

ACCREDITED BY  
THE DUTCH COUNCIL  
FOR ACCREDITATION



DEKRA Certification B.V. Utrechtseweg 310, 6812 AR Arnhem P.O. Box 5185, 6802 ED Arnhem The Netherlands  
T +31 26 3 56 20 00 F +31 26 3 52 58 00 www.dekra-certification.com Registered Arnhem 09085396





ANNEX TO KEMA-KEUR CERTIFICATE 2143500.02

page 1 of 1

#### SPECIFICATION OF THE CERTIFIED PRODUCT

##### Product data

product : connecting box for fixed electrical installations  
trade name : JSL  
types : J100L, J100B and J100S  
degree of protection : IP 66  
classification impact : IK8  
material : thermoplastic  
rated installation voltage : 500V~  
dimensions : 102x102x56mm  
colour : grey

##### Product data - type J100L

model : closed

##### Product data - type J100B

model : with rubber grommets B25 for cable or pipe diameters 16mm, 20mm and 25mm.

##### Product data - type J100S

model : with cable glands M-20 grey for cable diameters 8-13mm

#### TESTS

##### Test requirements

IEC 60670-1:2002 including C1:2003 and A1:2011  
IEC 60670-22:2003  
IEC 62262:2002

##### Test result

The test results are laid down in DEKRA test file 2143500.02.

##### Conclusion

The examination proved that all test requirements were met.

Tested by : R. van Daalen

Checked by : A.A. Mackenbach

##### Factory location

JSL Material Electrico S.A.  
Rua Mário Castelhana N° 3  
2746 Queluz De Baixo Apartado 12  
Portugal

DEKRA Certification B.V. Utrechtseweg 310, 6812 AR Arnhem P.O. Box 5185, 6802 ED Arnhem The Netherlands  
T +31 26 3 56 20 00 F +31 26 3 52 58 00 www.dekra-certification.com Registered Arnhem 09085396







# CERTIFICATE

Issued to:  
Applicant:  
**JSL Material Electrico S.A.**  
Rua Mário Castelhana Nº 3  
2746 Queluz De Baixo Apartado 12  
Portugal

Manufacturer/Licensee:  
**JSL Material Electrico S.A.**  
Rua Mário Castelhana Nº 3  
2746 Queluz De Baixo Apartado 12  
Portugal

Product : connecting box for fixed electrical installations  
Trade name : JSL  
Type : J160 L and J160 B

The product and any acceptable variation thereto is specified in the Annex to this certificate and the documents therein referred to.

DEKRA hereby declares that the above-mentioned product has been certified on the basis of:

- a type test according to the standard IEC 60670-1:2002, IEC 60670-22:2003 and IEC 62262:2002
- an inspection of the production location according to CENELEC Operational Document CIG 021
- a certification agreement with the number 961626

DEKRA hereby grants the right to use the KEMA-KEUR certification mark.

The KEMA-KEUR certification mark may be applied to the product as specified in this certificate for the duration of the KEMA-KEUR certification agreement and under the conditions of the KEMA-KEUR certification agreement.

This certificate is issued on: 13 May 2011 and expires upon withdrawal of one of the above mentioned standards.

**Certificate number: 2143500.03**

DEKRA Certification B.V.



drs. G.J. Zoetbrood  
Managing Director

H.R.M. Barends  
Certification Manager

© Integral publication of this certificate is allowed

All testing, inspection, auditing and certification activities of the former KEMA Quality are an integral part of the DEKRA Certification Group.

ACCREDITED BY  
THE DUTCH COUNCIL  
FOR ACCREDITATION



DEKRA Certification B.V. Utrechtseweg 310, 6812 AR Arnhem P.O. Box 5185, 6802 ED Arnhem The Netherlands  
T +31 26 3 56 20 00 F +31 26 3 52 58 00 www.dekra-certification.com Registered Arnhem 09085396



DOCUMENT SIGNED  
DIGITALLY



ANNEX TO KEMA-KEUR CERTIFICATE 2143500.03

page 1 of 1

#### SPECIFICATION OF THE CERTIFIED PRODUCT

##### Product data

product : connecting box for fixed electrical installations  
trade name : JSL  
types : J160 L and J160 B  
degree of protection : IP 66  
classification impact : IK8  
material : thermoplastic  
rated installation voltage : 500V~  
dimensions : 166x116x70mm  
colour : grey

##### Product data - type J160 L

model : closed

##### Product data - type J160 B

model : with rubber grommets B25 for cable or pipe diameters 16mm, 20mm and 25mm.

#### TESTS

##### Test requirements

IEC 60670-1:2002 including C1:2003 and A1:2011  
IEC 60670-22:2003  
IEC 62262:2002

##### Test result

The test results are laid down in DEKRA test file 2143500.03.

##### Conclusion

The examination proved that all test requirements were met.

Tested by : R.van Daalen

Checked by : A.A. Mackenbach

##### Factory location

JSL Material Electrico S.A.  
Rua Mário Castelhana N° 3  
2746 Queluz De Baixo Apartado 12  
Portugal

DEKRA Certification B.V. Utrechtseweg 310, 6812 AR Arnhem P.O. Box 5185, 6802 ED Arnhem The Netherlands  
T +31 26 3 56 20 00 F +31 26 3 52 58 00 www.dekra-certification.com Registered Arnhem 09085396







# CERTIFICATE

Issued to:  
Applicant:  
**JSL Material Electrico S.A.**  
Rua Mário Castelhana Nº 3  
2746 Queluz De Baixo Apartado 12  
Portugal

Manufacturer/Licensee:  
**JSL Material Electrico S.A.**  
Rua Mário Castelhana Nº 3  
2746 Queluz De Baixo Apartado 12  
Portugal

Product : connecting box for fixed electrical installations  
Trade name : JSL  
Types : J200 L and J200 B

The product and any acceptable variation thereto is specified in the Annex to this certificate and the documents therein referred to.

DEKRA hereby declares that the above-mentioned product has been certified on the basis of:

- a type test according to the standard IEC 60670-1:2002, IEC 60670-22:2003 and IEC 62262:2002
- an inspection of the production location according to CENELEC Operational Document CIG 021
- a certification agreement with the number 961626

DEKRA hereby grants the right to use the KEMA-KEUR certification mark.

The KEMA-KEUR certification mark may be applied to the product as specified in this certificate for the duration of the KEMA-KEUR certification agreement and under the conditions of the KEMA-KEUR certification agreement.

This certificate is issued on: 13 May 2011 and expires upon withdrawal of one of the above mentioned standards.

**Certificate number: 2143500.04**

DEKRA Certification B.V.



drs. G.J. Zoetbrood  
Managing Director

H.R.M. Barends  
Certification Manager

© Integral publication of this certificate is allowed

All testing, inspection, auditing and certification activities of the former KEMA Quality are an integral part of the DEKRA Certification Group.

ACCREDITED BY  
THE DUTCH COUNCIL  
FOR ACCREDITATION



DEKRA Certification B.V. Utrechtseweg 310, 6812 AR Arnhem P.O. Box 5185, 6802 ED Arnhem The Netherlands  
T +31 26 3 56 20 00 F +31 26 3 52 58 00 www.dekra-certification.com Registered Arnhem 09085396





ANNEX TO KEMA-KEUR CERTIFICATE 2143500.04

page 1 of 1

#### SPECIFICATION OF THE CERTIFIED PRODUCT

##### Product data

product : connecting box for fixed electrical installations  
trade name : JSL  
types : J200 L and J200 B  
degree of protection : IP 66  
classification impact : IK8  
material : thermoplastic  
rated installation voltage : 500V~  
dimensions : 216x166x90mm  
colour : grey

##### Product data - type J200L

model : closed

##### Product data - type J200B

model : with rubber grommets B32 for cable or pipe diameters 16mm, 20mm, 25mm and 32mm.

#### TESTS

##### Test requirements

IEC 60670-1:2002 including C1:2003 and A1:2011  
IEC 60670-22:2003  
IEC 62262:2002

##### Test result

The test results are laid down in DEKRA test file 2143500.04.

##### Conclusion

The examination proved that all test requirements were met.

Tested by : R. van Daalen

Checked by : A.A.Mackenbach

##### Factory location

JSL Material Electrico S.A.  
Rua Mário Castelhana Nº 3  
2746 Queluz De Baixo Apartado 12  
Portugal

DEKRA Certification B.V. Utrechtseweg 310, 6812 AR Arnhem P.O. Box 5185, 6802 ED Arnhem The Netherlands  
T +31 26 3 56 20 00 F +31 26 3 52 58 00 www.dekra-certification.com Registered Arnhem 09085396





Association for the Promotion of Research and Fire Safety Technology



MINISTERIO  
DE INDUSTRIA, ENERGÍA  
Y TURISMO

MINISTRY OF INDUSTRY, ENERGY AND TOURISM

**Tomás de la Rosa Sánchez**, General Manager of AFITI declares:

- That AFITI (Association for the Promotion of Research and Fire Safety Technology), is a non profit-making association and was declared Association of Public Utility by the Spanish Cabinet on 27th January 1995.
- That the ownership of LICOF (Centre for Fire Testing and Research) is of Ministry of Industry, Energy and Tourism, by R.D. 1614/85 and O.M. on 21st may 1991, corresponding, by agreement, the management to AFITI.
- That the tests included in this Technical Report have been carried out at the Technical Unit of Test (LICOF).
- That these tests have been developed under the framework of agreement signed between the Association for the Promotion of Research and Fire Safety Technology (AFITI) and Association for Wood Research and Development of Castilla-La Mancha (A.I.M.C.M.).

A handwritten signature in red ink, consisting of stylized initials and a surname, positioned above a vertical red line.

Signed: Tomás de la Rosa Sánchez  
General Manager

Recognition / Accreditation: MINISTRY OF INDUSTRY, ENERGY AND TOURISM, MINISTRY OF PUBLIC WORKS, IMO & VKF-AEAI.

Notify Body: NOTIFY BODY TO THE EUROPEAN COMMISSION WITH NR. 1168.

Member of: AELAF, AENOR, ASELF, AIDICO, EGOLF & NFPA.

**HEAD OFFICE & LABORATORIES** Camino del Estrechillo, 8  
E-28500 Arganda del Rey - Madrid (Spain)

**CENTRAL OFFICE & LABORATORIES** C/ Río Estenilla, s/n - P.I. Sta. M<sup>a</sup> de Benquerencia  
E-45007 Toledo (Spain)

+34 902 112 942  
+34 901 706 587  
licof@afiti.com  
www.afiti.com

